

BCA Assessment Report

REF Submission - Design Development Phase
Batemans Bay Community Health
7 Pacific Street, Batemans Bay NSW 2536

Prepared for:
BD Infrastructure

Revision 3
15 July 2024
Reference: 240062



bmplusg.com.au

Liability limited by a scheme approved under Professional Standards Legislation.

Executive Summary

The following comprises a summary of the key compliance issues identified under the clause-by-clause assessment in Section 3.0 and 4.0 that will be addressed prior to the issue of the BCA Crown Certificate for the project.

A. Key Compliance Items:

+ BCA (DTS) Clause		+ Description
1.	A6G1 & A6G6	<p><i>Building Classification</i></p> <p>The building has been classified as Class 5 in accordance with Clause A6G1 and A6G6.</p>
2.	B1D3	<p><i>Importance Level</i></p> <p>The Importance Level provisions of BCA (Section B) are to be acknowledged by the Structural Engineer and addressed to the degree necessary. In this instance it is noted that the Structural Engineer has nominated the building as being required to be designed and constructed in accordance with Importance Level 3.</p>
3.	C2D2 / Spec 5	<p><i>Location of Community Health Building in proximity to the existing Temporary Demountable Building</i></p> <p>The external walls of part of part of the Northern Elevation and Eastern Elevation that are situated less than 3 m from the Temporary Demountable Building on site will be required to be provided with an FRL in order to comply with Specification 5. This would require the parts of the external wall to have an FRL of 90/90/90 (if less than 1.5m) and 60/60/60 (if less than 3.0 m).</p> <p>Due to the fact that the proposed development is causing a non-compliance with the respect to the existing Demountable Building on site, the external wall of the Demountable Building and any associated openings that are situated less than 3 m from the Community Health Building would also be required to be provided with an FRL.</p> <p>Due to the impracticality of providing an FRL to the existing wall of the Demountable Building, the proposed design solution is for the external wall of the Community Health Building to be protected in both directions.</p> <p>In this instance, the proposed protection of the external walls and any associated openings of the Community Health Building and existing Demountable Building is proposed to be assessed as part of the Fire Engineering Assessment to be undertaken by Arup in order to demonstrate compliance with the nominated Performance Requirements of the BCA.</p> <p>It is noted that the proposed Fire Engineering Assessment by Arup requires the external walls of the Community Health Building that are situated within 3m of the existing Demountable Building to be provided with an FRL of 90/90/90 which is achieved in both directions. Based on the external wall of the Community Health Building being protected in both directions as part of the Fire Engineering Assessment, there is no requirement for the external wall of the existing Demountable Building to be protected.</p>
4.	C2D10	<p><i>Non-Combustible External Walls</i></p>

		<p>All materials and or components incorporated in an external wall or fire-rated wall must be non-combustible. This includes but not limited to:</p> <ul style="list-style-type: none"> + Any external wall claddings. + Any framing or integral formwork systems i.e., timber framing, sacrificial formwork, etc. + Any external linings or trims i.e., external UPVC window linings, timber window blades, etc. + Any sarking or insulation contained within the wall assembly. <p>This is not an exhaustive list, and any element incorporated within any external wall assembly must be identified and approved prior to the issue of a Crown Certificate.</p> <p>Refer to Table 1 in Appendix 1 for the elements required to be non-combustible.</p> <p>Note that these works are subject to NSW HI DGN 32 and as such <u>bonded laminate cladding is not permitted</u>.</p>
<p>5.</p>	<p>C4D3</p>	<p><i>Protection of External Walls exposed to another Building on the same Allotment</i></p> <p>Openings in the external wall of the Community Health Building have been positioned a minimum distance of 3m from the external wall of existing Demountable Building.</p> <p>The protection of the external walls and any associated openings of the existing Demountable Building are being assessed as part of the Fire Engineering Assessment to be undertaken by Arup as detailed in Clause C2D2.</p>
<p>6.</p>	<p>Part D4</p>	<p><i>Access for a Person with a Disability from the Property Boundary</i></p> <p>Access for a person with a disability is required to be provided to and within the building from the allotment boundary providing access to the building, from all accessible car parking spaces and from any accessways providing access to and from adjoining buildings on the hospital site.</p> <p>The proposed development can comply with the proposed access requirements of the BCA and AS 1428.1.</p> <p>Further details will need to be submitted in several instances to confirm compliance.</p>
<p>7.</p>	<p>E1D2</p>	<p><i>Fire Hydrants</i></p> <p>Fire hydrant coverage is required to be provided to the building in accordance with AS2419.1–2021 due to the building having a floor area exceeding 500 m².</p> <p><i>External Hydrants</i></p> <p>The proposed locations of the external fire hydrants are more than 10 m from the external walls of the proposed building they are providing coverage to. The fire hydrant within the car park which is within 10 m of the external wall of the demountable building is not a non-compliance as the fire hydrant is not providing coverage to demountable building.</p> <p><i>Fire Hydrant Booster</i></p> <p>The existing fire hydrant booster serving the existing Batemans Bay Hospital Site is located facing Pacific Street. The existing fire hydrant booster will be relied upon to serve the proposed Community Health.</p>

		<p>Having regard to the location of the existing booster relative to the main entrance of the proposed Community Health Building, compliance cannot be achieved with Clause 7.3 of AS 24198.1 – 2021 which requires the booster to be located within sight of the principal pedestrian entrance of the building.</p> <p>The location of the existing booster relative to the Community Health Building is proposed to be assessed as part of the Fire Engineering Assessment to be undertaken by Arup to demonstrate compliance with the nominated Performance Requirements of the BCA.</p>
8.	E1D2	<p><i>Fire Hose Reels</i></p> <p>A fire hose reel system is not required to be installed within a Class 5 building. Verification is required from HI / LHD as to whether a fire hose reel system is required to be installed within the building irrespective of the concession granted by the DTS Provisions of the BCA.</p>
9.	E1D4 – E1D13	<p><i>Sprinklers:</i></p> <p>Sprinklers not required to be installed within the building based on the building classification along with the effective height of the building.</p> <p>Notwithstanding the minimum requirements of the BCA, Health Infrastructure to provide written confirm there is no requirement for sprinklers to be installed throughout the building Health Infrastructures Engineering Services Guidelines.</p>
10.	E2D3 – E2D21	<p><i>Automatic Fire Detection & Alarm System</i></p> <p>Based on the building classification and rise in storeys of the building, there is no requirement for an Automatic Fire Detection & Alarm System to be installed throughout the building.</p> <p>Notwithstanding the minimum requirements of the BCA, it is noted that it proposed install an Automatic Fire Detection & Alarm System throughout the Community Building in accordance with AS 1670.1 – 2018.</p> <p>Fire Detection Control Indicating Equipment (FDCIE) will be installed within the Main Entry of the Community Health Building. The new FDCIE will be connected to the main FDCIE (located at the main hospital) and will act as a sub-panel. The main panel is readily accessible and new block plans will be provided to indicate the Community Health Building and new sub-panel.</p> <p>It is noted that the Fire Services Designer (GHD) has provided written verification that the Automatic Fire Detection & Alarm System is not required to be extended to the building undercroft due to its open nature and the spurious alarm nature of the undercroft area.</p>
11.	F3D2	<p><i>Roof Coverings:</i></p> <p>A roof covering is required to comply with one of the following in accordance with NCC 2022 as part of a DTS Solution:</p> <ul style="list-style-type: none"> + Roof tiles complying with AS 2049 and fixed in accordance with AS 2050; or + Metal sheet roofing complying with AS 1562.1; or + Plastic sheet roofing designed and installed in accordance with AS 1562.3; or

		<ul style="list-style-type: none"> + Terracotta, fibre-cement and timber slates and shingles designed and installed in accordance with AS 4597. + An external waterproofing membrane consisting of materials complying with AS 4654.1 and designed and installed in accordance with AS 4654.2 <p>If the proposed roof covering is not designed in accordance with one of the above, then a Performance Solution will be required to be prepared to demonstrate compliance with Performance Requirement F3P1 with regards to adequate weatherproofing.</p>
<p>12.</p>	<p>F4D4</p>	<p><i>Sanitary Facilities for Staff</i></p> <p>Sanitary facilities must be provided to comply with the requirements of F4D4.</p> <p>In relation to the proposed sanitary facilities indicated on the Design Development Architectural Drawings, the following items are noted:</p> <ul style="list-style-type: none"> + Verification is required as to the total number of staff that will be employed to work in the building at a single time to ensure that an adequate number of sanitary facilities are provided having regard to staffing numbers. <p>Based on the current provision of only (2) dedicated staff sanitary facilities (one of which is a unisex accessible sanitary facility) the total male and female staff that can be employed is as follows:</p> <ul style="list-style-type: none"> ▲ Female Staff – 30 ▲ Male Staff – 20 <p>It is noted that the Design Development Design has deleted a Staff Sanitary Facility from the previously issued Schematic Design. The reduction has resulted in their being no numerical allocation of a urinal for male staff.</p> <p>If the unisex accessible sanitary facility located within the Waiting Room area can be used by staff and members of the public, then compliance will be provided for the provision of a urinal for male staff.</p> <p>Written verification is to be provided from the LHD that the unisex accessible sanitary facility within the Waiting Room area can be used by LHD staff and that the anticipated female and male staff numbers will not exceed those detailed above.</p> <p><i>Public Sanitary Facilities</i></p> <p>Sanitary facilities for the public are technically not required to be provided within a building of Class 5 classification.</p> <p>Notwithstanding the requirements of the BCA, it is noted that a unisex accessible sanitary facility for use by a person with a disability has been provided within the Waiting Room in addition to a sanitary facility for a member of the public within the consultation area.</p> <p><i>Unisex Sanitary Facilities</i></p> <p>If unisex sanitary facilities are provided for staff in lieu of separate male and female facilities which is required by the DTS Provisions, then a Performance Solution will be required to be prepared to demonstrate compliance with the nominated Performance Requirements of the BCA.</p>
<p>13.</p>	<p>F4D5</p>	<p><i>Unisex Accessible Facilities and Ambulant Sanitary Compartments</i></p>

Having regard to the proposed Design Development Architectural Design, the following is noted in relation to the provision of sanitary facilities for a person with a disability:

- + An accessible unisex sanitary facility for use by a person is provided within the Waiting Area for use by members of the public. Verification is required to be provided from the LHD as to whether staff will be permitted to use and share the facility with the public.
- + An accessible unisex sanitary facility comprising a shower for use by a staff member with a disability is provided within the staff area as detailed in the figure below.
- + A unisex ambulant sanitary compartment for a staff member is provided within the staff area as detailed below.
- + The unisex public sanitary facility provided within the consultation area will be required to be designed and constructed as an ambulant sanitary compartment. It is noted that at present, the public sanitary facility has not been designed as an ambulant sanitary compartment.

Unisex Ambulant Sanitary Compartments

The provision of unisex ambulant sanitary compartments provided for staff in lieu of separate male and female ambulant compartments which is required by the DTS Provisions, will be required to be subject of a Performance Solution to prepared by an independent Access Consultant to demonstrate compliance with the nominated Performance Requirements of the BCA.

B. Summary of Items Potentially Requiring a Fire Engineering Performance Solution:

+ BCA DTS Clause		+ BCA Performance Requirement	+ Description
1.	C2D2 & C4D3	C1P2	Proximity of part of the external walls of the proposed Community Health building to the existing Temporary Demountable Building
2.	E1D1	E1P3	Location of the existing fire hydrant booster serving the hospital site and its proximity to the main entrance of the proposed Community Health Building.

C. Summary of Items Requiring a Performance Solution:

+ BCA (DTS) Clause		+ BCA Performance Requirement	+ Description
1.	F3D5	F3P1	Waterproofing of external walls
2.	F4D4	F4P1	Males and females sharing sanitary facilities
3.	F4D4	F4P1	Males and females sharing unisex ambulant sanitary compartments

+ Contents

Executive Summary	1
A. Key Compliance Items:.....	1
B. Summary of Items Potentially Requiring a Fire Engineering Performance Solution:	5
C. Summary of Items Requiring a Performance Solution:	5
1.0 Description of Project.....	8
1.1 Proposal	8
1.2 Aim	8
1.3 Project Team.....	9
1.4 Referenced Documentation	9
1.5 Regulatory Framework	9
1.6 Relevant Version of the NCC Building Code of Australia	9
1.7 Compliance with the National Construction Code.....	10
1.8 Limitations and Exclusions	11
1.9 Report Terminology	12
2.0 Building Characteristics	14
2.1 Proposed Development.....	14
2.2 Fire Compartment Floor Area Limitations	15
2.3 Distance to Fire Source Features	15
3.0 BCA Assessment.....	16
3.1 Section A – Governing Requirements	16
3.2 Section B – Structure.....	17
3.3 Section C – Fire Resistance.....	18
3.4 Parts D – Provision for Escape and Construction of Exits	22
3.5 Section E – Services and Equipment.....	30
3.6 Section F – Health and Amenity	35
3.8 Section J – Energy Efficiency	39
4.0 Conclusion.....	40
+ Appendix 1 – References Tables	42

+ Report Status

+ Date	15 July 2024
+ Revision	3
+ Status	Issued for Design Development Phase – REF Submission
+ Author	Adam Durnford
+ Reviewed	David Blackett

Prepared by:

Adam Durnford
 Director
BM+G
 Building Surveyor-Unrestricted (NSW)
BDC No.: 1821

Reviewed by:

David Blackett
 Director
BM+G
 Building Surveyor-Unrestricted (NSW)
BDC No.: 0032

+ Revision History

+ Revision	0	+ Date	26.04.2024
+ Status	Schematic Design Phase		
+ Revision	1	+ Date	26.04.2024
+ Status	Schematic Design Phase – REF Submission		
+ Revision	2	+ Date	09.07.2024
+ Status	Design Development Phase		
+ Revision	3	+ Date	15.07.2024
+ Status	Design Development Phase – REF Submission		

1.0 Description of Project

1.1 Proposal

BM+G Pty Ltd have been commissioned by BD Infrastructure to undertake an assessment of the Design Development Architectural Documentation for the new Batemans Bay Community Health Centre at 7 Pacific Street, Batemans Bay NSW 2536 against the relevant provisions of the Building Code of Australia 2022 (BCA).

An assessment of BCA compliance with respect to the new works is included within Section 3.0.



Figure No. 1 – View to Main Entry from the Existing Batemans Bay Hospital Path

1.2 Aim

The aim of this report is to:

- + Undertake an assessment of the proposed development against the deemed-to-satisfy provisions of the BCA.
- + Identify matters that require plan amendments in order to achieve compliance with the BCA.
- + Identify matters that are to be required to be addressed by Performance Solutions.
- + Enable the Public Authority to satisfy its statutory obligations under Section 6.28 of the Environmental Planning and Assessment Act, 1979.

- + Identify matters relating to the existing building that are required to be addressed as an upgrade strategy to accommodate the new works and / or to deal with significant fire safety issues within the building.

1.3 Project Team

The following BM+G team members have contributed to this Report:

- + **Adam Durnford** – Report Preparation (Director) | Building Surveyor-Unrestricted
- + **David Blackett** – Peer Review (Director) | Building Surveyor-Unrestricted

1.4 Referenced Documentation

The following documentation has been reviewed, referenced and/or relied upon in the preparation of this report:

- + Building Code of Australia 2022 (BCA)
- + NSW Health Infrastructure Design Guidance Note 32.
- + NSW Health Engineering Services Guide dated 12 December 2022.
- + Design Development Architectural Documentation prepared by Conrad Gargett dated 20 May 2024.

1.5 Regulatory Framework

- + Pursuant to S6.28 of the Environmental Planning and Assessment Act 1979, the proposed building is subject to compliance with the relevant requirements of the BCA as in force at the time of the date of invitation for tenders to carry out the Crown building work.

1.6 Relevant Version of the NCC Building Code of Australia

Pursuant to Section 6.28 of the Environmental Planning and Assessment Act 1979, the proposed building is subject to compliance with the relevant requirements of the BCA as in force at the time of the date of invitation for tenders to carry out the Crown building work. The current BCA that is in force is BCA 2022, with BCA 2025 coming in to force 1 May 2025. As the invitation to tender is likely to be / has been lodged after 1 May 2023, this report assesses the design against compliance with the requirements of BCA 2022.

The following parts of the BCA are subject to transitional provisions:

- + NCC 2022 Energy Efficiency provisions – 1 October 2023.
- + NCC 2022 Condensation Management provisions under BCA Part F8 – 1 October 2023.

1.7 Compliance with the National Construction Code

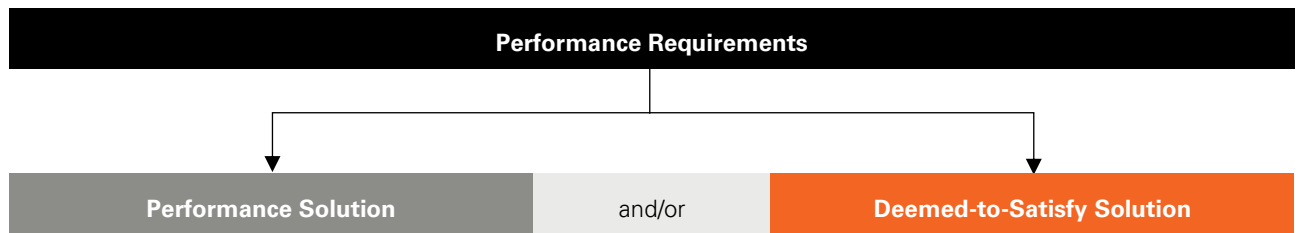

Compliance with the NCC is achieved by complying with:

- + the Governing Requirements of the NCC; and
- + the Performance Requirements.

Performance Requirements are satisfied by one of the following, as shown in the Figure below:

- + A Performance Solution.
- + A Deemed-to-Satisfy Solution.
- + A combination of the above two options.

Where a *Performance Requirement* is proposed to be satisfied by a *Performance Solution*, the following steps must be undertaken:

- + Prepare a performance-based design brief in consultation with relevant stakeholders.
- + Carry out analysis, using one or more of the Assessment Methods listed in A2G2(2), as proposed by the performance-based design brief.
- + Evaluation the results against the acceptance criteria in the performance-based design brief.
- + Prepare a final report that includes:
 - All Performance Requirements and/or Deemed-to-Satisfy provisions identified through A2.2(3) or A2G4(3) as applicable; and
 - Identification of all Assessment Methods used; and
 - Details of steps (a) to (c); and
 - Confirmation that the Performance Requirement has been met; and
 - Details of conditions or limitations, if any exist, regarding the Performance Solution.

1.8 Limitations and Exclusions

The limitations and exclusions of this report are as follows:

- + No assessment has been undertaken with respect to the Disability Discrimination Act 1992 (DDA). The building owner needs be satisfied that their obligations under the DDA have been addressed.
 - + Please note that whilst the BCA specifies a minimum standard of compliance with AS1428 (Parts 1-3) and Part D4 of the BCA for access and facilities for people with disabilities, compliance with such requirements may not necessarily preclude the possibility of a future complaint made under the DDA 1992. The DDA is a complaint-based legislation and is presently not identified by the State Building Codes and Regulations. In this regard the building owner should be satisfied that their obligations under the DDA have been addressed.
 - + No assessment has been undertaken with respect to the following areas of the NCC:
 - Structural
 - Weatherproofing
 - Waterproofing
 - Acoustic
 - Passive Fire Protection
 - DDA / Accessibility
 - Section J / ESD
 - Fire Safety Engineering
 - + No assessment has been undertaken with respect to SEPP (Housing) 2021. It is understood that suitably qualified consultants will be engaged to determine the relevance of any Council planning requirements or SEPP requirements and provided detailed assessment reports where applicable.
- Where relevant to this development, it is assumed that these assessments will be undertaken by others.
- + This report does not consider BCA Part G5 (Volume 1) which makes provision for construction of buildings in bushfire-prone areas, therefore no assessment has been undertaken in consideration of RFS, Planning for Bushfire Protection and AS 3959. Where Part G is applicable to the site, then it is required that assessment / due diligence is undertaken by a specialist consultant to verify compliance.
 - + This report does not constitute a detailed assessment of the architectural documentation against the requirements of Section J. It is understood that a suitably qualified consultant will be engaged to determine compliance in this regard.
 - + **BM+G** has not undertaken an assessment of any Performance Solution Reports at the time of the preparation of this report.
 - + The Report does not address matters in relation to the following Local Government Act and Regulations:
 - Work Health and Safety Act and Regulations.
 - Work Cover Authority requirements.
 - Water, drainage, gas, telecommunications and electricity supply authority requirements.
 - Disability Discrimination Act 1992.
 - + **BM+G** cannot guarantee acceptance of this report by Local Council, Fire & Rescue NSW or other approval authorities.
 - + This report may not be relied upon under the provisions of the Design and Building Practitioners Act & Regulation for the purposes of issuing a Design Compliance Declaration.
 - + No part of this document may be reproduced in any form or by any means without written permission from **BM+G**. This report is based solely on client instructions, and therefore should not be used by any third party without prior knowledge of such instructions.

1.9 Report Terminology

BCA Completion Certificate – A certificate issued at the completion of works which confirms the building is suitable for occupation in accordance with its classification under the BCA.

BCA Crown Certificate – A certificate issued against building works carried out by or on behalf of the Crown which verifies that the works comply with the requirements of the BCA prior to works commencing, subject to S6.28 of the Environmental Planning and Assessment Act 1979.

Building Code of Australia – Document published on behalf of the Australian Building Codes Board. The BCA is a uniform set of technical provisions for the design and construction of buildings and other structures throughout Australia and is adopted in NSW under the provisions of the Environmental Planning & Assessment Act & Regulation.

Climatic Zone – Means an area defined in Figure 2 and in Table 2 (of BCA Schedule 3) for specific locations, having energy efficiency provisions based on a range of similar climatic characteristics.

Construction Certificate – Building Approval issued by the Certifying Authority pursuant to Part 6 of the EP&A Act 1979.

Construction Type – The construction type is a measure of a buildings ability to resist a fire. The minimum type of fire-resisting construction of a building must be that specified in Table C2D2 and Specification 5, except as allowed for:

- + certain Class 2, 3 or 9c buildings in C2D6; and
- + a Class 4 part of a building located on the top storey in C2D4(2); and
- + open spectator stands and indoor sports stadiums in C2D8.

Note: Type A construction is the most fire-resistant and Type C the least fire-resistant of the types of construction.

Deemed-to-Satisfy (DTS) Provisions of the BCA – Means the prescriptive provisions of the BCA which

are deemed to satisfy the performance requirements.

Effective Height – The vertical distance between the floor of the lowest storey included in the calculation of rise in storeys and the floor of the topmost storey (excluding the topmost storey if it contains only heating, ventilating, lift, or other equipment, water tanks or similar service units).

Exit – Any, or any combination of the following if they provide egress to a road or open space:

- + An internal or external stairway.
- + A ramp.
- + A fire-isolated passageway.
- + A doorway opening to a road or open space.

Fire Compartment – The total space of the building; or when referred to in

- + The Performance Requirements – any part of a building separated from the remainder by barriers to fire such as walls and/or floors having an appropriate resistance to the spread of fire with any openings adequately protected; or
- + The Deemed-to-Satisfy Provisions – any part of a building separated from the remainder by walls and/or floors each having an FRL not less than that required for a fire wall for that type of construction and where all openings in the separating construction are protected in accordance with the Deemed-to-Satisfy Provisions of the relevant part.

Fire Resistance Level (FRL) – The grading periods in minutes for the following criteria:

- + structural adequacy; and
- + integrity; and
- + insulation.

and expressed in that order.

Fire Source Feature (FSF) – The far boundary of a road adjoining the allotment; or a side or rear boundary of the allotment; or an external wall of another building on the allotment which is not a Class 10 building.

Health-care building: A building whose occupants or patients undergoing medical treatment generally need physical assistance to evacuate the building during an emergency and includes—

- + a public or private hospital; or
- + a nursing home or similar facility for sick or disabled persons needing full-time care; or
- + a clinic, day surgery or procedure unit where the effects of the predominant treatment administered involve patients becoming non-ambulatory and requiring supervised medical care on the premises for some time after the treatment.

Horizontal exit: A required doorway between 2 parts of a building separated from each other by a fire wall.

National Construction Code Series (NCC) – The NCC was introduced 1 May 2011 by the Council of Australian Governments (COAG). The BCA Volume One (Class 2 to 9 Buildings) is now referenced as the National Construction Code Series Volume One — BCA.

Occupiable outdoor area means a space on a roof, balcony or similar part of a building:

- + that is open to the sky; and
- + to which access is provided, other than access only for maintenance; and
- + that is not open space or directly connected with open space.

Occupation Certificate (OC) – Building Occupation Approval issued by the Principal Certifying Authority pursuant to Part 6 of the EPA Act 1979.

Open Space – Means a space on the allotment, or a roof or other part of the building suitably protected from fire, open to the sky and connected directly with a public road.

Patient Care Area – A part of a healthcare building normally used for the treatment, care, accommodation, recreation, dining and holding of patients including a ward area and treatment area.

Performance-based Design Brief – Means the process and the associated report that defines the scope of work for the performance-based analysis, the technical basis for analysis, and the criteria for acceptance of any relevant Performance Solution as agreed by stakeholders.

Performance Requirements of the BCA – A Building Solution will comply with the BCA if it satisfies the Performance Requirements. A Performance requirement states the level of performance that a Building Solution must meet.

Compliance with the Performance Requirements can only be achieved by-

- + complying with the Deemed-to-Satisfy Provisions; or
- + formulating an Alternative Solution which-
 - complies with the Performance Requirements; or
 - is shown to be at least equivalent to the Deemed-to-Satisfy Provisions; or
- + a combination of the above.

Performance Solution – Means a method of complying with the performance requirements other than by a Deemed-To-Satisfy Solution.

Treatment area – An area within a patient care area such as an operating theatre and rooms used for recovery, minor procedures, resuscitation, intensive care and coronary care from which a patient may not be readily moved.

Ward area – That part of a patient care area for resident patients and may contain areas for accommodation, sleeping, associated living and nursing facilities.

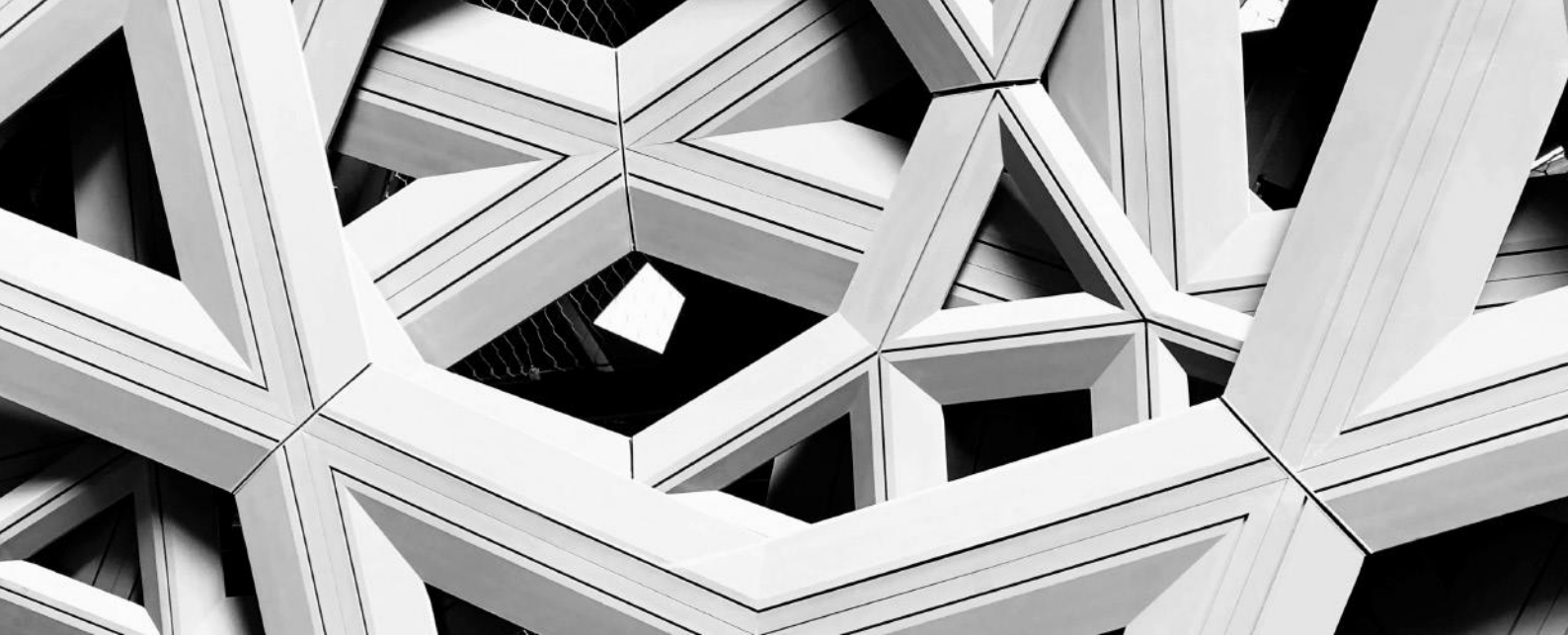

2.0 Building Characteristics

2.1 Proposed Development

The existing building is classified as follows:

+ BCA Classifications:	Class 5 (Community Health and Staff Administration)
+ Rise in Storeys:	Two (2)
+ Storeys Contained:	Two (2)
+ Type of Construction:	Type C Construction
+ Importance Level (Structural)	Importance Level 3 as nominated by the Structural Engineer
+ Sprinkler Protected Throughout	Sprinklers not required to be installed within the building based on the building classification. Health Infrastructure to confirm there is no requirement for Sprinklers to be installed as per their Engineering Services Guidelines
+ Effective Height	< 12 m
+ Floor Area	Approx 818 m ²
+ Largest Fire Compartment	< 3,000 m ²
+ Climate Zone	Zone 6

2.2 Fire Compartment Floor Area Limitations

Maximum size of fire compartment/atria is:

+ Classification		+ Type A	+ Type B	+ Type C
5, 9b or 9c	Max. floor area	8,000m ²	5,500m ²	3,000m ²
	Max. volume	48,000m ³	33,000m ³	18,000m ³

2.3 Distance to Fire Source Features

Based upon a review of the plans, it is noted that each elevation of the building is located within the following distances from fire source features on the site.

+ Elevation	+ Fire Source Feature	+ Distance
North (Part)	Building on same allotment	< 3 m
East (Part)	Building on same allotment	< 3m
West	Building on same allotment	> 3m
South	Building on same allotment	> 3m

Note: Fire Source Feature (FSF) – The far boundary of a road adjoining the allotment; or a side or rear boundary of the allotment; or an external wall of another building on the allotment which is not a Class 10 building.

3.0 BCA Assessment

We note the following BCA compliance matters with relation to proposed building works are capable of complying with the BCA. Please note that this is not a full list of BCA clauses, they are the key requirements that relate to the proposed work and the below should be read in conjunction with the BCA.

3.1 Section A – Governing Requirements

Part A6 Building Classification

A6G1 & A6G6

The building has been classified as Class 5 in accordance with Clause A6G1 and A6G6.

It is noted that the Community Health Building contains two (2) rooms that are identified as treatment rooms.

The LHD has provided the following response in terms of the use rooms:

'The main treatment administered by community nursing would be wound care, catheter management, case management in addition to other assessment and treatment of minor issues. There will be no use of nitrous gases, sedatives or anaesthetics in this space that would inhibit a patient's ability to evacuate in case of an emergency.'

As a result of the written confirmation from the LHD, the use of the rooms does not trigger any Class 9a use and thus the classification of Class 5 applies to the entire building.

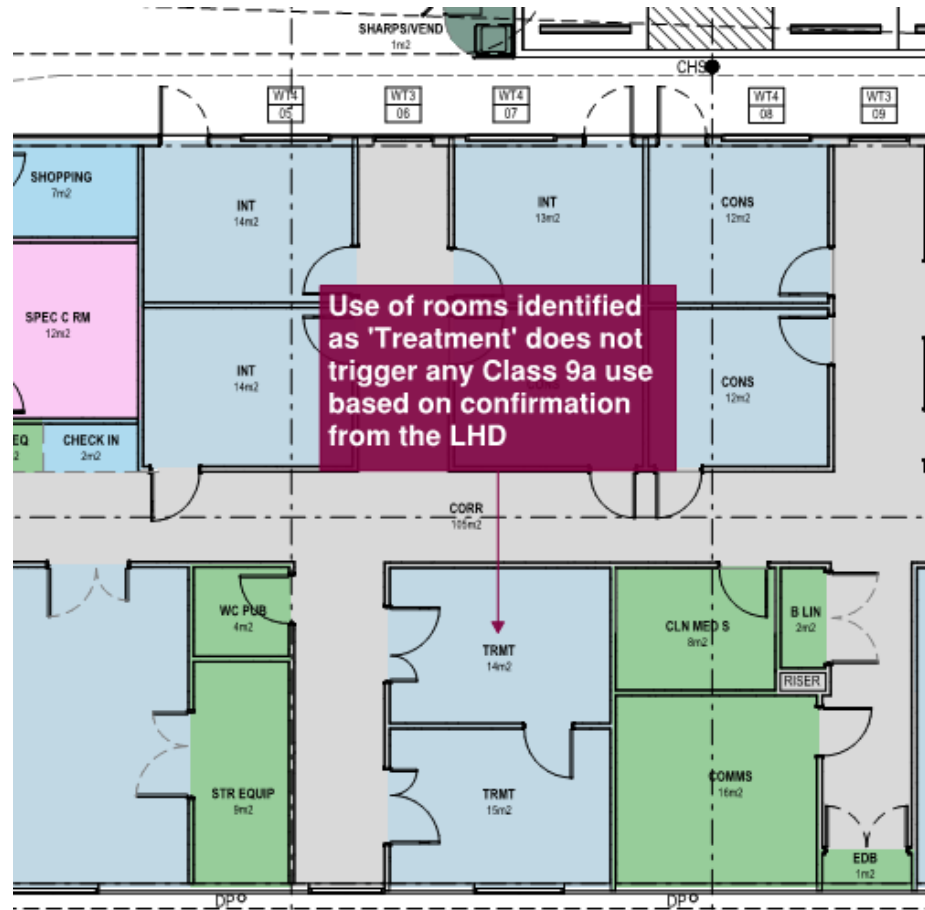

Figure No. 2 – Rooms identified as 'Treatment Rooms' do not contain a use that triggers a Class 9a use

3.2 Section B – Structure

Part B1

Structural Provisions:

- + New building works are to comply with the structural provisions of the BCA 2022 and referenced standards including AS 1170.
- + The Importance Level provisions of BCA (Section B) are to be acknowledged by the Structural Engineer and addressed to the degree necessary. In this instance it is noted that the Structural Engineer has identified the building required to be designed in accordance with Importance Level 3.
- + The building design is required to be designed in accordance with earthquake provisions of AS1170.4 – Earthquake Actions in Australia.

3.3 Section C – Fire Resistance

Part C2 Fire Resistance and Stability

C2D2 /
Spec 5

Type of Construction Required:

The building is required to comply with the requirements of Type C Construction as stated within Specification 5. The table below provides an overview of the requirements of each. Refer to Table 6 of Appendix 1 for the FRL requirements of Type C Construction.

+ Type C Construction:

- + External walls (and columns incorporated within) need not achieve an FRL if > 3m from an allotment boundary or separate building. Where required, external walls of Type C Construction only require an FRL from the outside and not in both directions.
- + Roofs need not achieve an FRL.
- + Internal columns need not achieve an FRL.

The external walls of part of the Northern Elevation and Eastern Elevation that are situated less than 3 m from the Temporary Demountable Building on site will be required to be provided with an FRL in order to comply with Specification 5. This would require the parts of the external wall to have an FRL of 90/90/90 (if less than 1.5m) and 60/60/60 (if less than 3.0 m).

Due to the fact that the proposed development is causing a non-compliance with the respect to the existing Demountable Building on site, the external wall of the Demountable Building and any associated openings that are situated less than 3 m from the Community Health Building would also be required to be provided with an FRL.

Due to the impracticality of providing an FRL to the existing wall of the Demountable Building, the proposed design solution is for the external wall of the Community Health Building to be protected in both directions.

In this instance, the proposed protection of the external walls and any associated openings of the Community Health Building and existing Demountable Building is proposed to be assessed as part of the Fire Engineering Assessment to be undertaken by Arup in order to demonstrate compliance with the nominated Performance Requirements of the BCA.

It is noted that the proposed Fire Engineering Assessment by Arup requires the external walls of the Community Health Building that are situated within 3m of the existing Demountable Building to be provided with an FRL of 90/90/90 which is achieved in both directions. Based on the external wall of the Community Health Building being protected in both directions as part of the Fire Engineering Assessment, there is no requirement for the external wall of the existing Demountable Building to be protected.

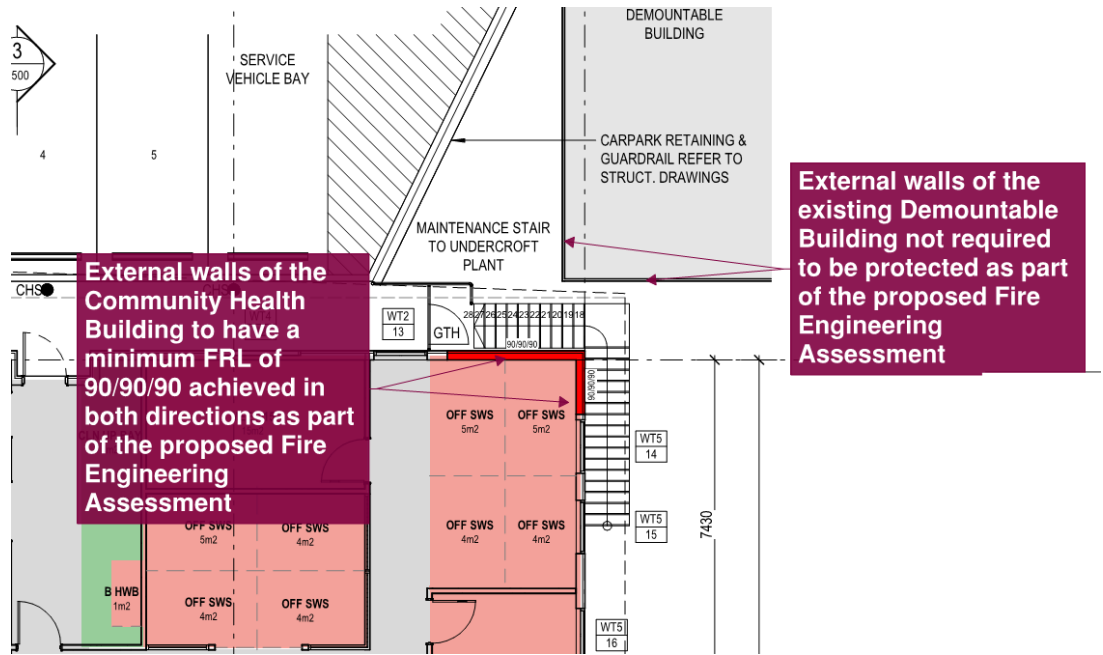

Figure No. 3 – Exposure of external walls of the Community Health Building to the Temporary Demountable Building

C2D10 / C2D14

Non-Combustible Building Elements:

All materials and or components incorporated in an external wall or fire-rated wall must be non-combustible. This includes but not limited to:

- + Any external wall claddings.
- + Any framing or integral formwork systems. I.e. timber framing, sacrificial formwork, etc.
- + Any external linings or trims. I.e. external UPVC window linings, timber window blades, etc.
- + Any sarking or insulation contained within the wall assembly.

This is not an exhaustive list, and any element incorporated within any external wall assembly must be identified and approved prior to the issue of a Crown Certificate.

Refer to Table 1 in Appendix 1 for the elements required to be non-combustible.

Note that these works are subject to NSW HI Design Guidance Note No. 32 and as such bonded laminate cladding is not permitted.

Ancillary Components within the External Wall Assembly

NCC 2022 permits the following building elements to be constructed within an external wall of a building of Type A or B Construction (or a building subject to HI DGN 32).

- + Caulking
- + Sealants
- + Termite management systems
- + Thermal breaks associated with –
 - Glazing systems, or
 - External wall systems, where the thermal breaks –
 - Are no larger than necessary to achieve thermal objectives, and
 - Do not extent beyond one storey, and

- Do not extend beyond one fire compartment.
- + Damp proof courses
- + Compressible fillers and backing materials, including those associated with articulation joints, closing gaps not wider than 50 mm.
- + Isolated—
 - ▲ construction packers and shims; or
 - ▲ blocking for fixing fixtures; or
 - ▲ fixings, including fixing accessories; or
 - ▲ acoustic mounts.
- + Waterproofing materials applied to the external face, used below ground level and up to 250 mm above ground level.
- + Joint trims and joint reinforcing tape and mesh of a width not greater than 50 mm.
- + Weather sealing materials, applied to gaps not wider than 50 mm, used within and between concrete elements.
- + Wall ties and other masonry components complying with AS 2699 Part 1 and Part 3 as appropriate and associated with masonry wall construction.
- + Reinforcing bars and associated minor elements that are wholly or predominately encased in concrete or grout.
- + A paint, lacquer or a similar finish or coating.
- + Adhesives, including tapes, associated with stiffeners for cladding systems.
- + Fire-protective materials and components required for the protection of penetrations.

The following materials, when entirely composed of itself, are non-combustible and may be used wherever a non-combustible material is required:

- + Concrete.
- + Steel, including metallic coated steel.
- + Masonry, including mortar.
- + Aluminium, including aluminium alloy.
- + Autoclaved aerated concrete, including mortar.
- + Iron.
- + Terracotta.
- + Porcelain.
- + Ceramic.
- + Natural stone.
- + Copper.
- + Zinc.
- + Lead.
- + Bronze.
- + Brass.

The following materials may be used where a non-combustible material is required:

- + Plasterboard
- + Perforated gypsum lath with a normal paper finish
- + Fibrous-plaster sheet
- + Fibre-reinforced cement sheeting
- + Pre-finished metal sheeting having combustible surface finish not exceeding 1mm thickness and where the Spread-of-Flame Index of the product is not greater than 0.
- + Sarking type materials that do not exceed 1 mm in thickness and have a Flammability Index not greater than 5.

Note: Bonded laminated materials (façade panels) are not permitted to be installed on the external façade of the building in accordance with Health Infrastructure Design Guidance Note 32 for external wall construction.

Part C3 Compartmentation and Separation

C3D3 General Floor Area and Volume Limitations:

The maximum size of any fire compartment with a Class 5 building cannot exceed 3,000 m² & 18,000 m³.

The Design Development Architectural Drawings indicate that compliance is achieved in this instance with total fire compartment size within the building not exceeding 3,000 m² & 18,000 m³.

Part C4 Protection of Openings

C4D3 & C4D5 Protection of Openings in External Walls:

Openings in the external wall of the Community Health Building have been positioned a minimum distance of 3m from the external wall of existing Demountable Building as detailed in the figure below.

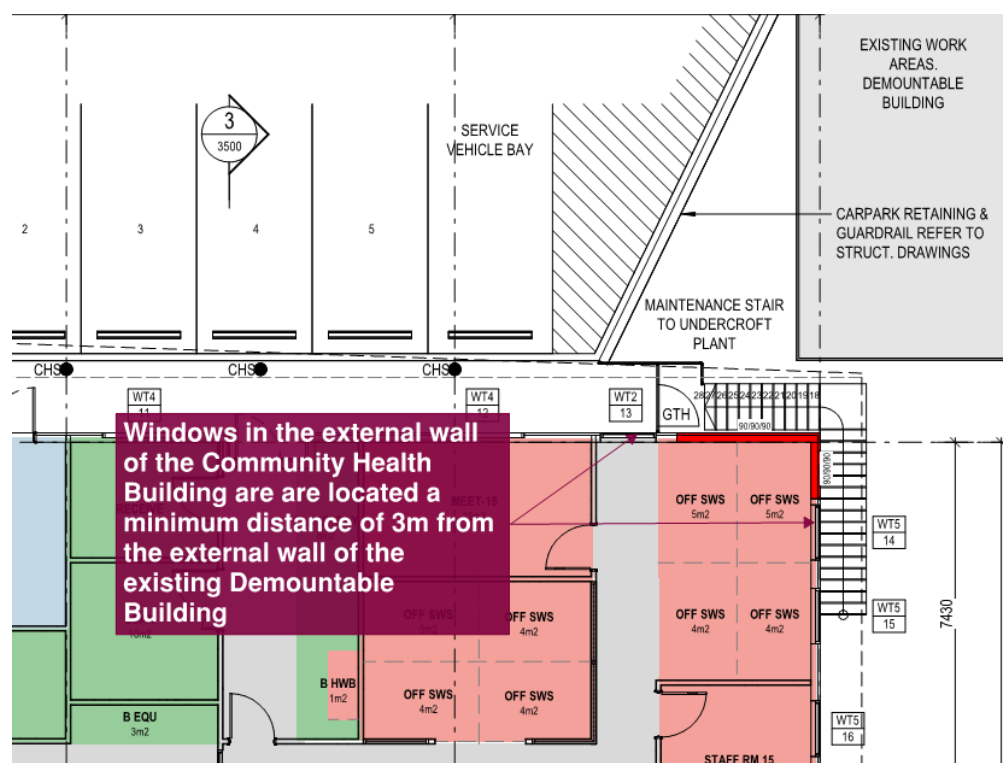

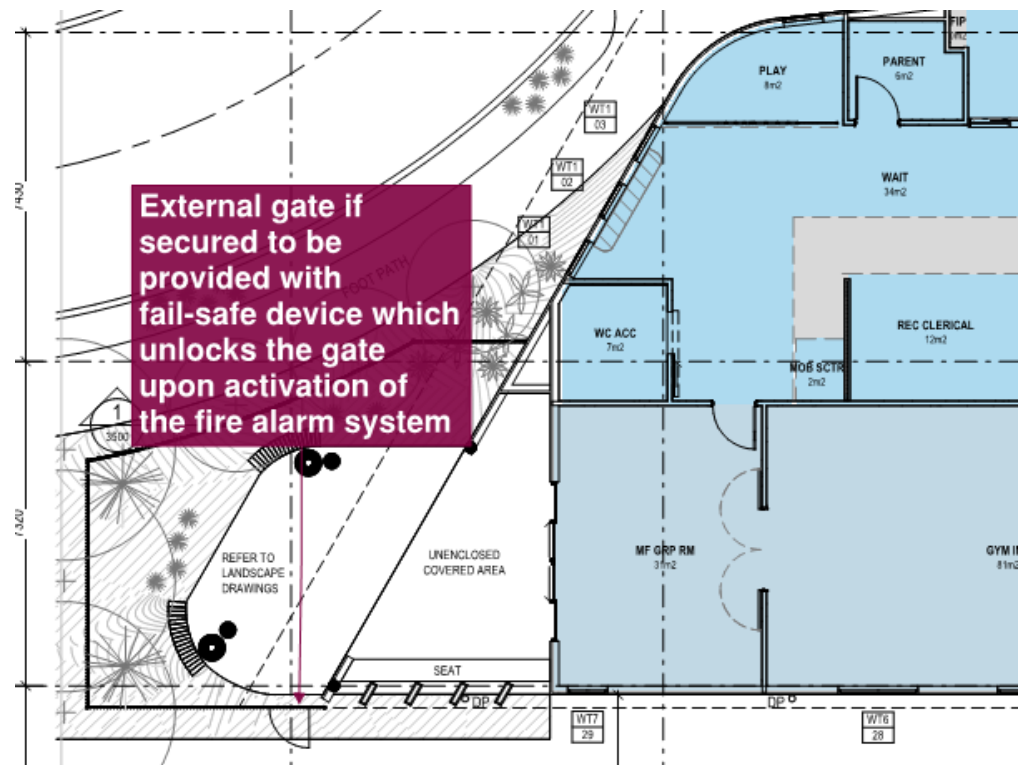

Figure No. 8 – Gate provided from the courtyard area on the Western Elevation of the building

D2D5 Distance Between Alternative Exits:

The maximum distance permitted between alternative exits is 60m. This must be measured back through the point of choice. Alternative egress paths are not permitted to converge to less than 6m, and alternative exits must be located a minimum distance of than 9m apart.

Based on the provision of exits as detailed in the figure above, travel distance between alternative exits complies.

Part D3 Construction of Exits

D3D9 Enclosure of Space under Stairs and Ramps:

The space below the external non fire isolated stairway cannot be enclosed to form a cupboard or other enclosed space unless –

- + The enclosing walls and ceilings have an FRL of not less than 60/60/60; and
- + Any access doorway to the enclosed space is fitted with a self-closing -/60/30 fire door.

The current Design Development Drawings do not indicate the provision of an enclosure beneath the external stairway.



Figure No. 9 – External non-fire isolated stairway on the Eastern Elevation with no proposed enclosure beneath

**D3D17-
D3D20** Barriers to Prevent Falls:

A continuous barrier is required to be provided along with the external stairway along with the landing at the top of the stairway along with the pathway adjoining the stairway.

The barrier is required to be a minimum of 1000 mm above the FFL of the landing and pathway and 865 mm along the stairway.

The openings in barriers cannot exceed 125 mm.

Where the level below the barrier is more than 4000 mm, no horizontal or near horizontal elements that could facilitate climbing between 150 mm and 760 mm above the floor can be included as part of the barrier design.

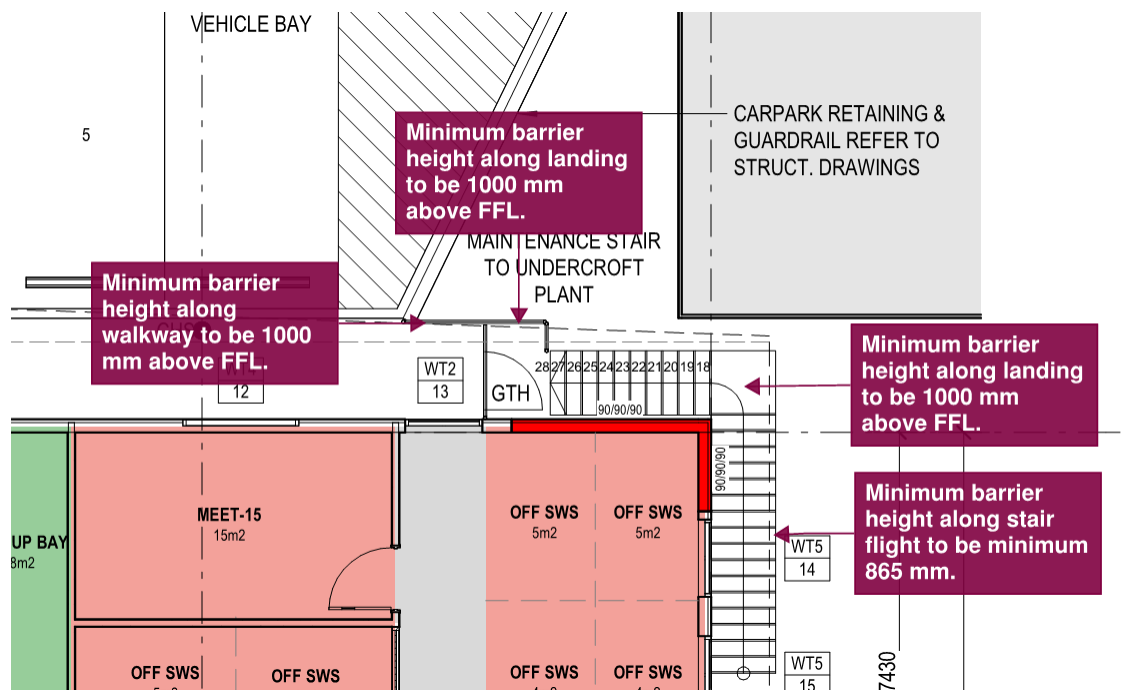

Figure No. 16: Required heights of barrier to external stairway and adjoining walkway

Part D4 Access for People with a Disability

D4D2 General Building Access Requirements:

Access for persons with disabilities must be provided, at a minimum, to and within all areas normally used by the occupants throughout the development.

Based on a review of the Architectural Design Development Documentation, the proposed development can comply with the requirements of Part D4 of the BCA.

D4D3

Access to Buildings:

A compliant accessway is required to be provided to the building from:

- + The main points of entry of a pedestrian entry at the allotment boundary; and
- + From any other accessible building connected by a pedestrian link; and
- + From any required accessible car parking space on the allotment

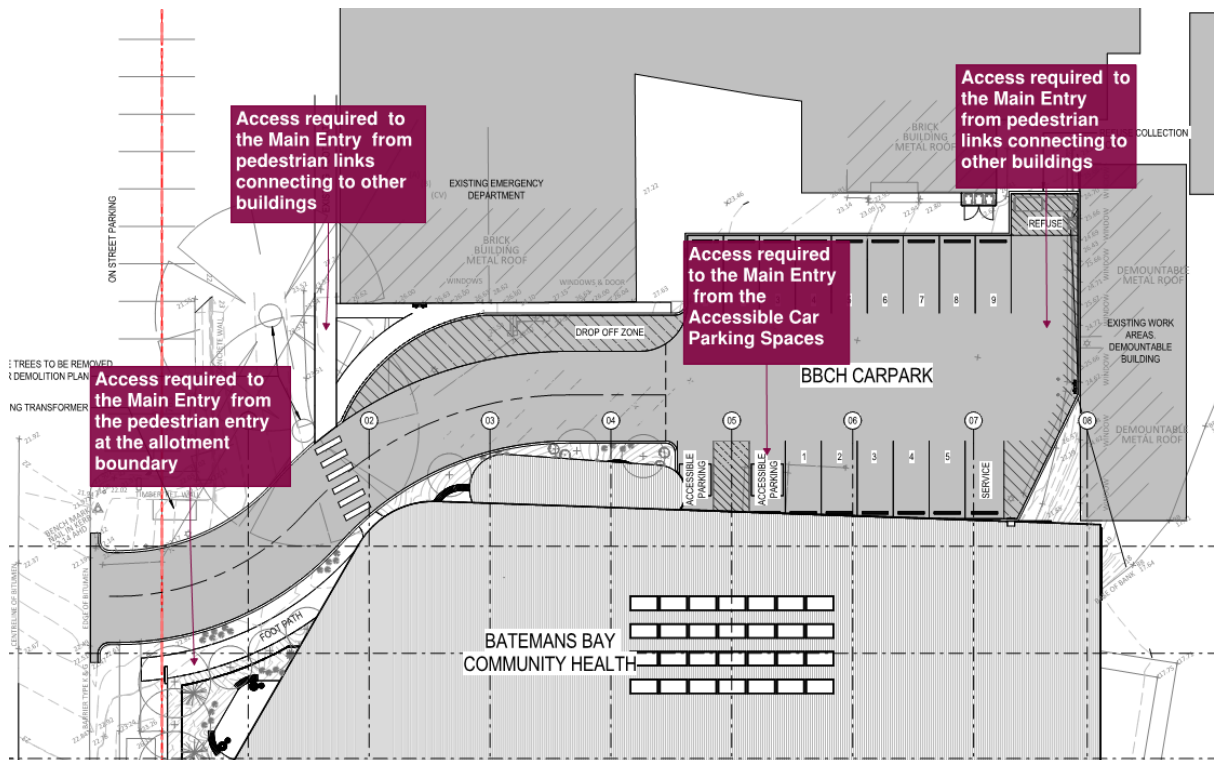

Figure No. 17: Required access to the building for a person with a disability

Accessible Path of Travel

- + The minimum unobstructed height of a continuous accessible path of travel is required to be 2000 mm and 1980 mm at doorways.

Unless otherwise specified (such as at doors, curved ramps and similar), the minimum unobstructed width of a continuous accessible path of travel is required to be 1000 mm and following elements cannot intrude into the minimum width:

- ▲ Fixtures and fittings such as lights, awnings, windows that when open intrude into the circulation space, telephones, skirtings, and similar objects.
- ▲ Essential fixture and fittings such as fire hose reels, fire extinguishers and switchboards.
- ▲ Door handles less than 900 mm above the finished floor.

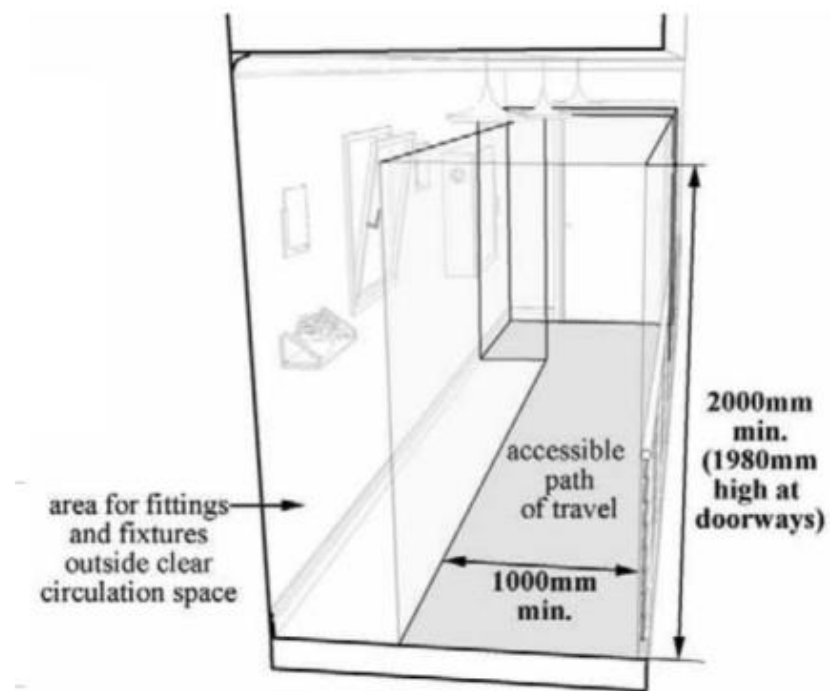

Figure No. 18: Minimum height and width of accessible path of travel

- + The minimum width of an accessible doorway must have a clear opening width of not less than 850mm in accordance with AS1428.1. Where double doors are provided, at least one leaf must have a clear unobstructed width of 850mm.

Note: -

Please refer to Clause D2D7 - D2D11 above having regard to the clear width of doorways where patient transportation in beds is required.

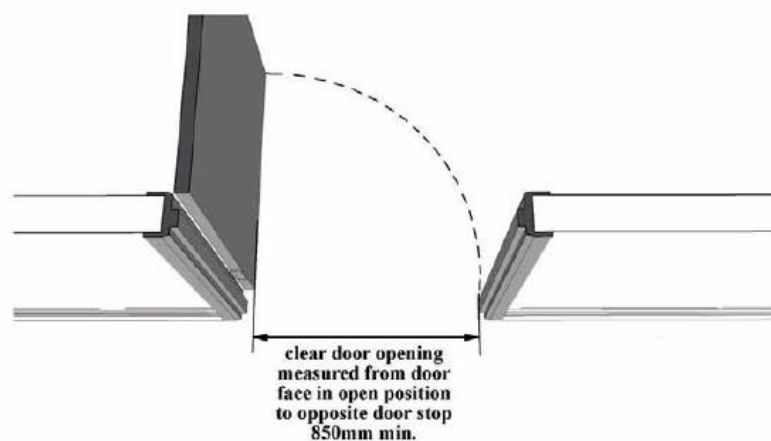

Figure No. 19: Clear Unobstructed Width of Doorway

- + All new doorways shall have a minimum luminance contrast of 30% provided between -
 - ▲ (a) door leaf and door jamb;
 - ▲ (b) door leaf and adjacent wall;
 - ▲ (c) architrave and wall;
 - ▲ (d) door leaf and architrave; or

- ▲ (e) door jamb and adjacent wall.

The minimum width of the area of luminance contrast shall be 50 mm.

Doorways providing access to rooms that are not required to be accessible, are not required to be provided with a luminance contrast i.e., clean utility rooms, dirty utility rooms, equipment stores etc.

- + Circulation space is required to all doorways throughout the building that are required to be accessible. Circulation space is not required to be provided to rooms where access for a person with a disability is not required i.e. dirty utility / clean utility rooms, plant rooms, comms rooms etc. See below required doorway circulation space for swinging and sliding doors. be accessible in accordance with Section 13 of AS 1428.1 – 2009 (see diagrams below).

Note: -

Where doorways are provided with one and half leaves, the half leaf is required to permit the required latch side circulation space as required by AS 1428.1 – 2009.

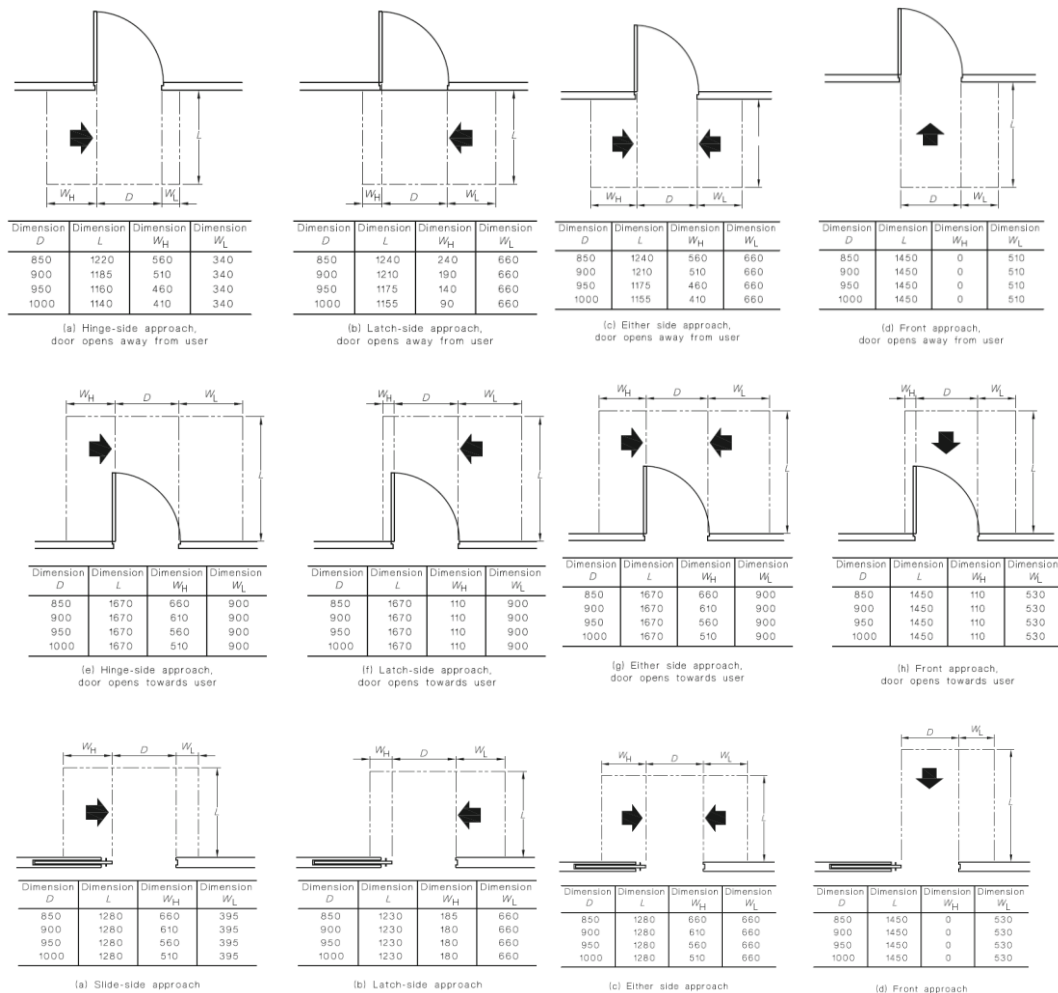

Figure No. 20: Circulation Space at Swing Doors

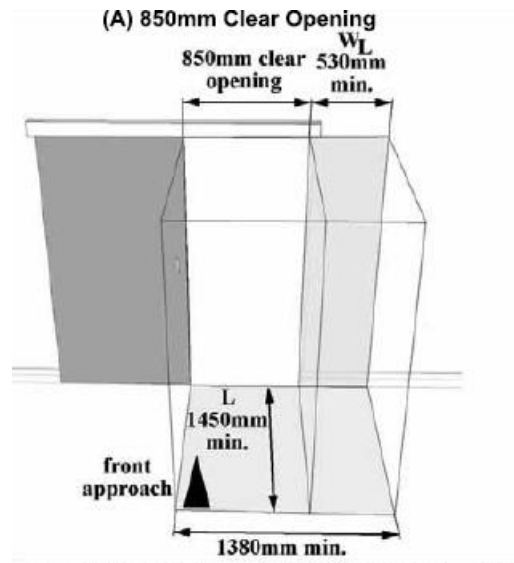

Figure No. 21: Circulation Space dimensions at swing doors

From a review of the Design Development Drawings, circulation space is currently deficient or requires close attention to the following doorways to ensure that compliance is achieved in accordance with AS 1428.1 – 2009.

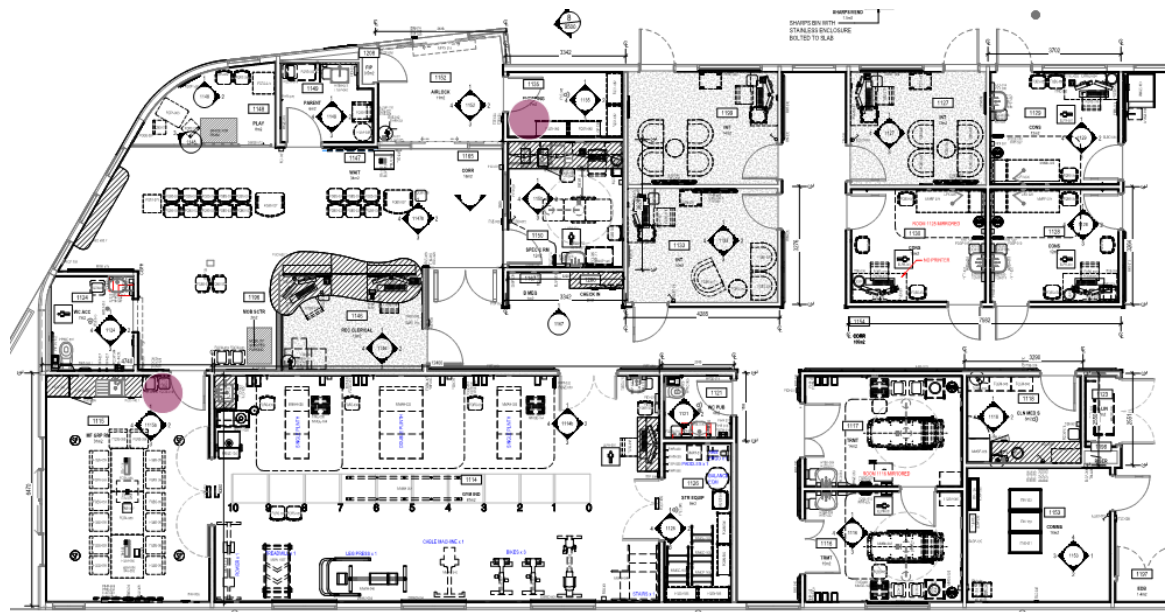

Figure No. 22: Doorways where circulation space is required to be reviewed in detail to ensure that compliance is achieved

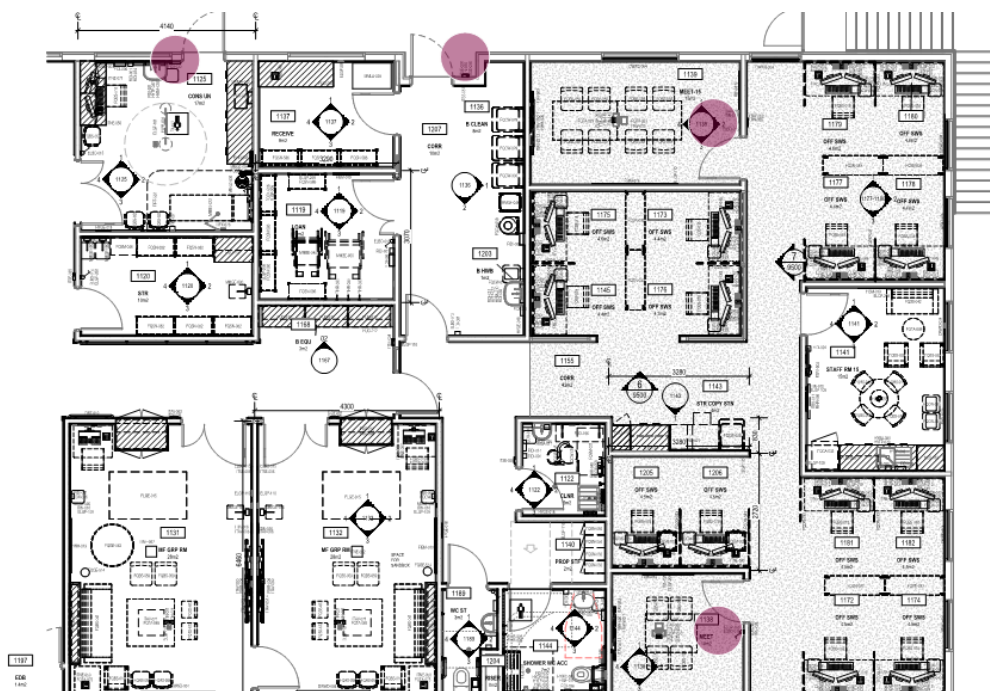

Figure No. 23: Doorways where circulation space is required to be reviewed in detail to ensure that compliance is achieved

D4D5

Exemptions:

The following areas are not required to be accessible:

- + An area where access would be inappropriate because of the particular purpose for which the area is used.
- + An area that would pose a health or safety risk for people with a disability.
- + Any path of travel providing access only to an area exempted by (a) or (b).

Areas / rooms that may not be required to be accessible for a person with a disability include the following:

- + Dirty Utility Rooms
- + Clean Utility Rooms
- + Equipment Storerooms
- + General Storerooms
- + Cleaners Rooms
- + Disposal Rooms
- + Back of House Area containing the Bulk Store, General Waste Room etc
- + Plant Rooms
- + Pump Rooms
- + Main Switch Room, Chamber Sub, UPS / EDB / Comms Rooms

The figure below identifies rooms that are available for a D4D5 concession.

The LHD are to provide written confirmation that access for any staff members with a disability would not be required to be provided to the identified rooms.



Figure No. 42: Rooms that are available to achieve a Clause D4D4 concession subject to written confirmation from the LHD

D4D6

Accessible Car Parking:

Accessible car parking spaces are required to be provided within the car parking area for a person with a disability.

The Design Development proposes two (2) accessible car parking spaces which ensure compliance with Clause D4D6.

The accessible car parking spaces will be required to be designed and constructed in accordance with AS 2890.6.

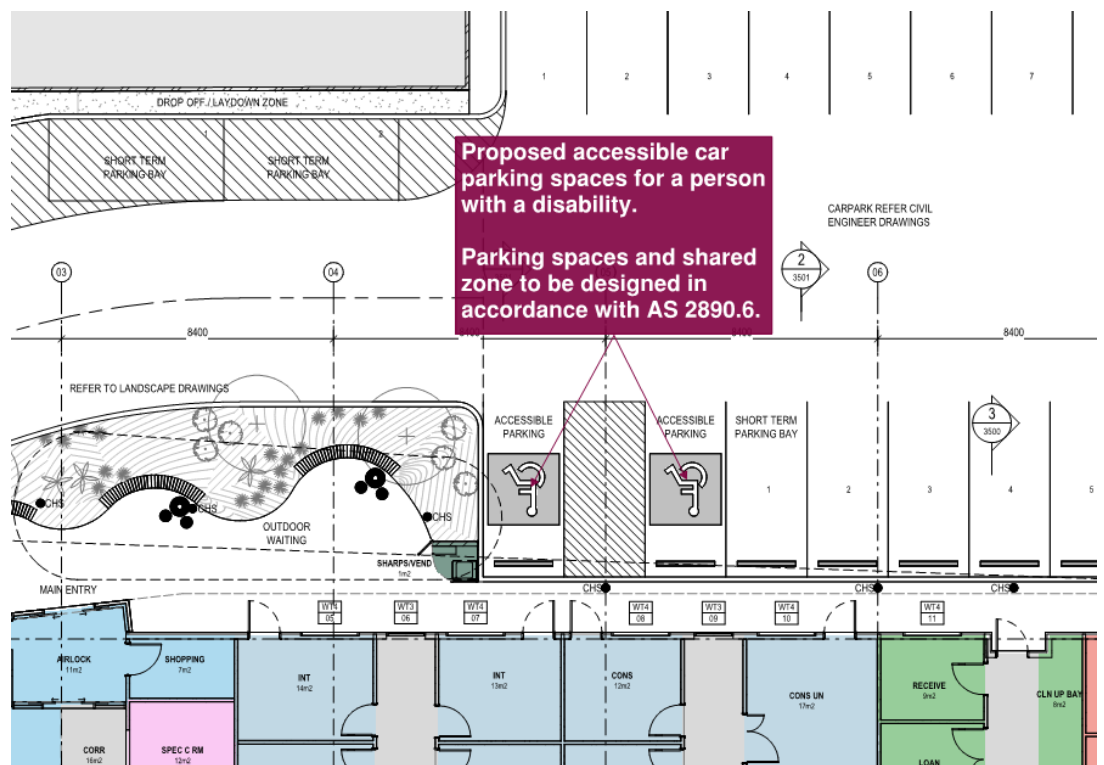

Figure No. 43: Proposed accessible car parking spaces for a person with a disability in proximity to the main entrance of the building

3.5 Section E – Services and Equipment

Part E1 Fire Fighting Equipment

E1D1

Fire Hydrants:

Fire hydrant coverage is required to be provided to the building in accordance with AS2419.1-2021 due to the building having a floor area exceeding 500 m².

External Hydrants

External hydrants are required to be located:

- + Not less than 10m from:
 - ▲ The external wall of the building unless fire protection is provided to the fire hydrant in accordance with Clause 3.5.5 of AS 2419.1 - 2021
 - ▲ Any high voltage electrical distribution equipment such as transformers and distribution boards
 - ▲ Any electric vehicle charging station regardless of voltage
 - ▲ Any stored quantity of dangerous goods
 - ▲ Any external combustible storage
- + Not less than 3m from the vent terminal of any gas assembly or gas measurement systems
- + Not less than 3m from the discharge outlet of any building exhaust system when operating in fire mode.

The figure below details the proposed location of the external fire hydrants serving the Community Health Building.

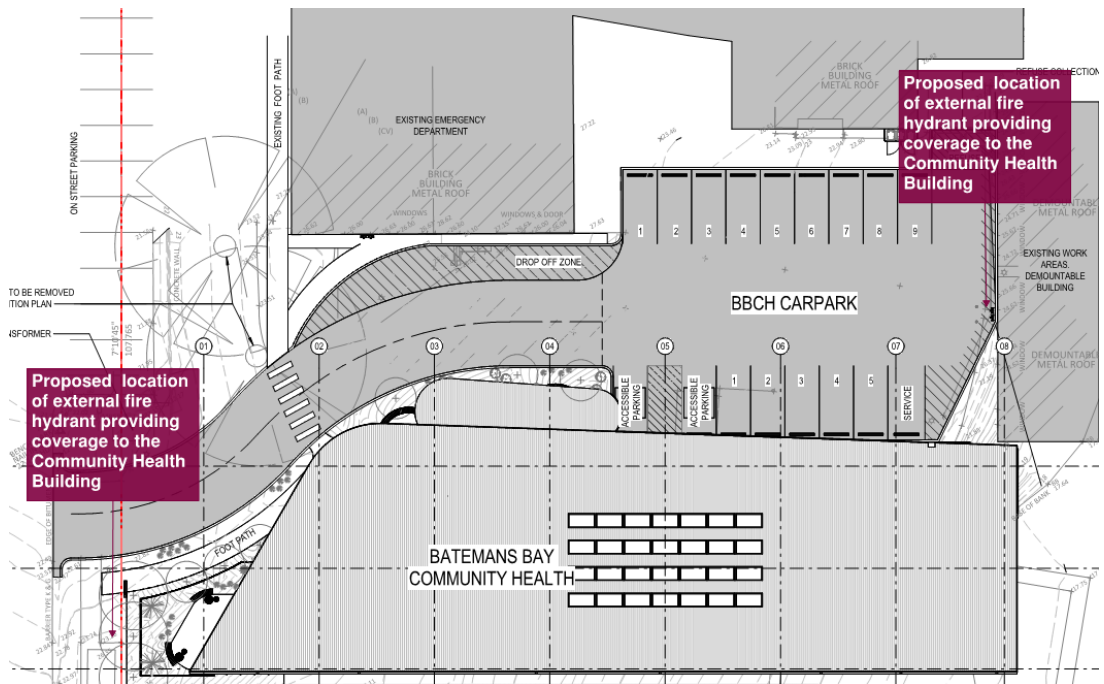

Figure No. 46: Location of proposed external fire hydrants serving the Community Health Building

The proposed locations of the external fire hydrants are more than 10 m from the external walls of the proposed building they are providing coverage to. The fire hydrant within the car park which is within 10 m of the external wall of the demountable building is not a non-compliance as the fire hydrant is not providing coverage to demountable building.

The external fire hydrant installed within the car park will be required to have bollards installed in front so that the booster cannot be obstructed by a parked motor vehicle. The external fire hydrant

installed facing Pacific Street is required to have unimpeded access in front of they hydrant and cannot be obstructed by landscaping etc.

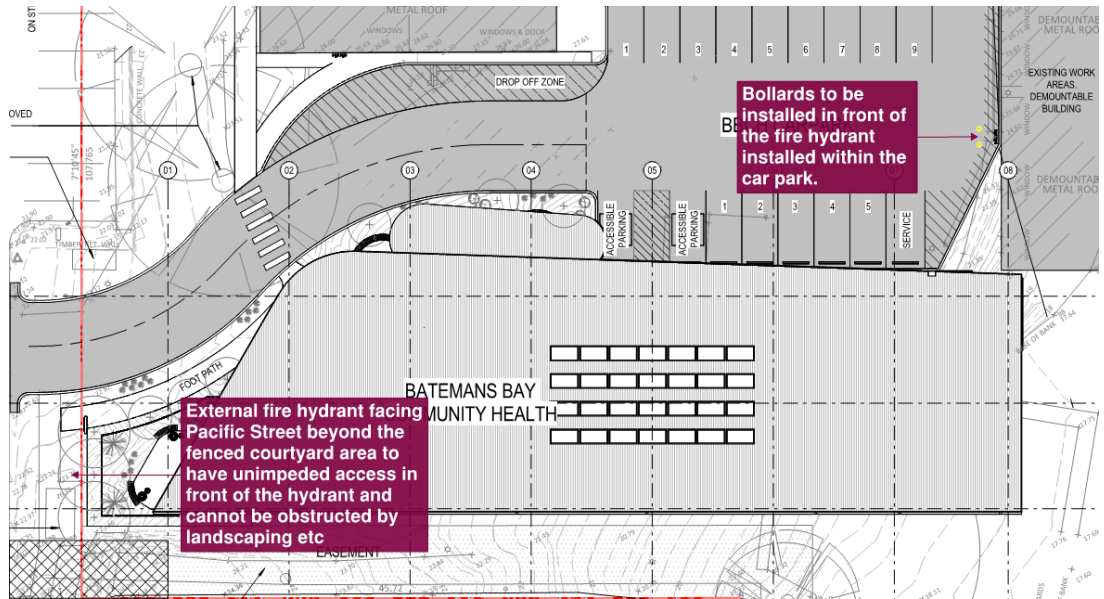

Figure No. 47: Unimpeded access required to external fire hydrants

Internal Hydrants

Internal fire hydrants are required to be located within 4 m of exits leading directly to open space. It is noted that the proposed design contains no internal fire hydrants.

Fire Hydrant Booster

The existing fire hydrant booster serving the existing Batemans Bay Hospital Site is located facing Pacific Street. The existing fire hydrant booster will be relied upon to serve the proposed Community Health.

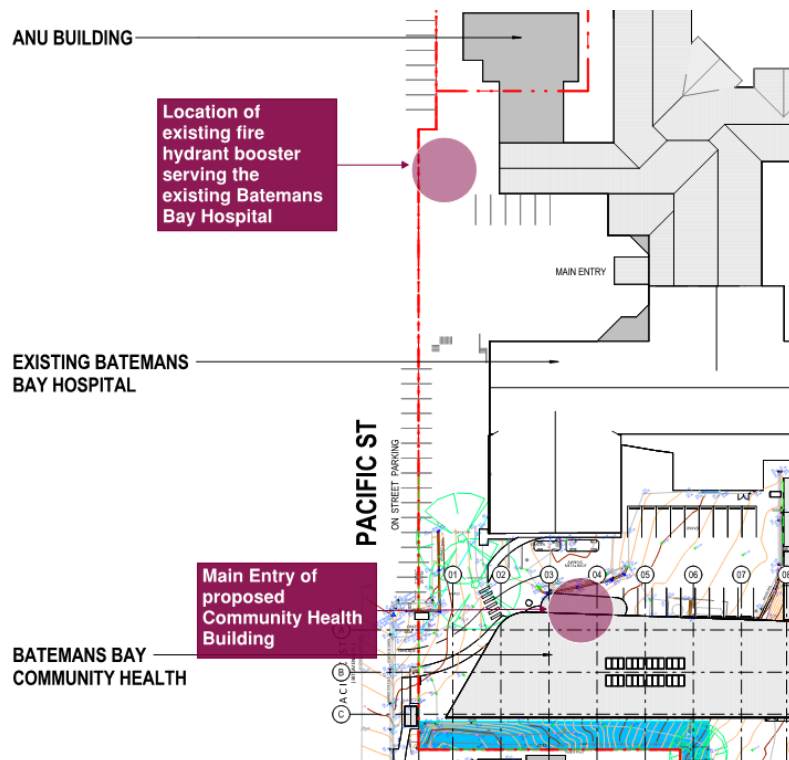

Figure No. 48: Location of existing fire hydrant booster serving the Batemans Bay Hospital site relative to the Main Entry of the proposed Community Health Building

Having regard to the location of the existing booster relative to the main entrance of the proposed Community Health Building, compliance cannot be achieved with Clause 7.3 of AS 24198.1 – 2021 which requires the booster to be located within sight of the principal pedestrian entrance of the building.

The location of the existing booster relative to the Community Health Building is proposed to be assessed as part of the Fire Engineering Assessment to be undertaken by Arup to demonstrate compliance with the nominated Performance Requirements of the BCA.

E1D3

Fire Hose Reels:

A fire hose reel system is not required to be installed within a Class 5 building.

Verification is required from HI / LHD as to whether a Fire Hose Reel system is required to be installed within the building irrespective of the concession granted by the DTS Provisions of the BCA.

**E1D4 –
E1D13**

Sprinklers:

Sprinklers not required to be installed within the building based on the building classification along with the effective height of the building.

Notwithstanding the minimum requirements of the BCA, Health Infrastructure to provide written confirm there is no requirement for sprinklers to be installed throughout the building Health Infrastructures Engineering Services Guidelines.

E1D14

Fire Extinguishers:

Portable fire extinguishers are to be installed throughout the building in accordance with Clause E1D14 and AS 2444 - 2001.

Part E2 Smoke Hazard Management

**E2D4/
E2D9/
E2D11/
E2D12/
E2D13**

Smoke Hazard Management:

Based on the building classification and rise in storeys of the building, there is no requirement for an Automatic Fire Detection & Alarm System to be installed throughout the building.

Notwithstanding the minimum requirements of the BCA, it is noted that it proposed install an Automatic Fire Detection & Alarm System throughout the Community Building in accordance with AS 1670.1 – 2018.

Fire Detection Control Indicating Equipment (FDCIE) will be installed within the Main Entry of the Community Health Building. The new FDCIE will be connected to the main FDCIE (located at the main hospital) and will act as a sub-panel. The main panel is readily accessible and new block plans will be provided to indicate the Community Health Building and new sub-panel.

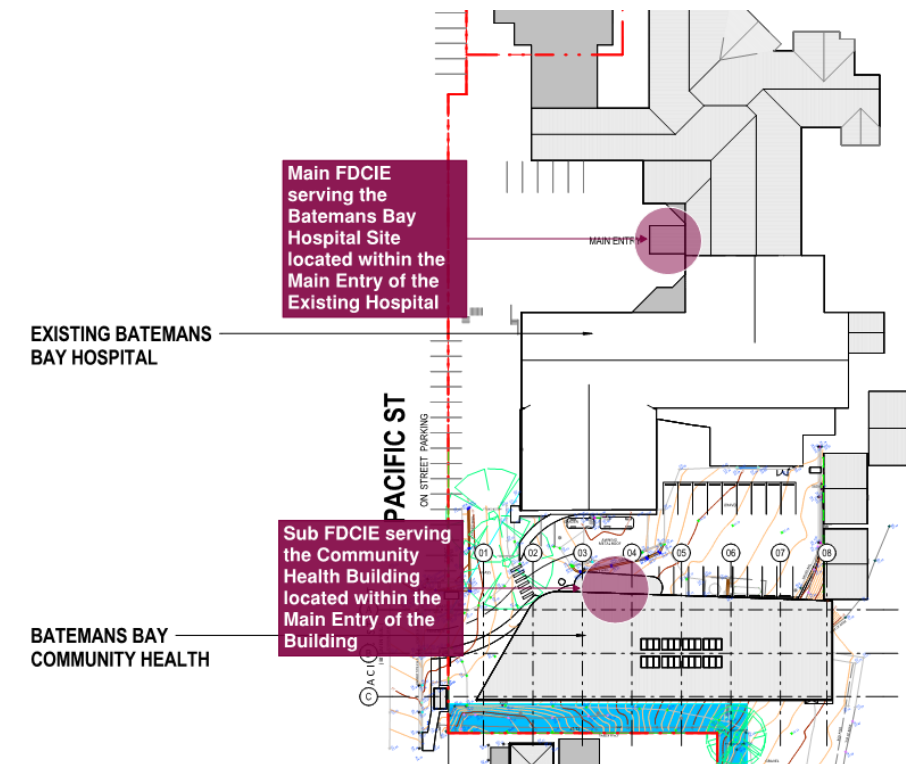

Figure No. 49: Location of Main FDCIE within the existing hospital and sub FDCIE within the Community Health Building

It is noted that the Fire Services Designer (GHD) has provided written verification that the Automatic Fire Detection & Alarm System is not required to be extended to the building undercroft due to its open nature and the spurious alarm nature of the undercroft area.

Part E4 Visibility in Emergency, Exit Signs and Warning Systems

E4D2 & E4D4

Emergency Lighting:

Emergency Lighting is required throughout the building in accordance with AS/NZS 2293.1 - 2018 in the following locations:

- + In every passageway, corridor, hallway or the like that is part of the path of travel to an exit;
- + In every room having a floor area of more than 100 m² that does not open to a corridor or space that has emergency lighting or to a road or open space;
- + In any room having a floor area more than 300 m².

E4D5, E4D6 & E4D8

Exits Signs:

Exit signs are to be installed throughout the building in accordance with AS/NZS 2293.1 - 2018 in the following locations:

- + Doors leading directly to open space;
- + Above doorways in a path of travel where the location of the exit is not clear.

Directional exit signs are to be installed throughout the building where the exits are not readily apparent to occupants in accordance with AS/NZS 2293.1 - 2018.

3.6 Section F – Health and Amenity

Part F1 Surface Water Management, Rising Damp & External Waterproofing

F1D3

Stormwater Drainage:

All new Stormwater Drainage serving the development is required to be designed and construction in accordance with AS/NZS 3500.3 – 2021.

Part F2 Wet Areas and Overflow Protection

F2D2 & F2D3

Wet Area Construction

Building elements in the bathroom or shower room, a slop hopper or sink compartment, a laundry or sanitary compartment is required:

- + Be water resistant or waterproof in accordance with Specification 26 (Specification 26 of NCC 2022); and
- + Be constructed in accordance with AS 3740

Floor Wastes

Where a floor waste is installed-

- + The minimum continuous fall of a floor plane to the waste must be 1:80; and
- + The maximum continuous fall of a floor plane to the waste must be 1:50
- + Where an accessible sanitary facility contains a toilet pan and shower, the minimum continuous fall of a floor plane to the waste throughout the room must be 1:80.

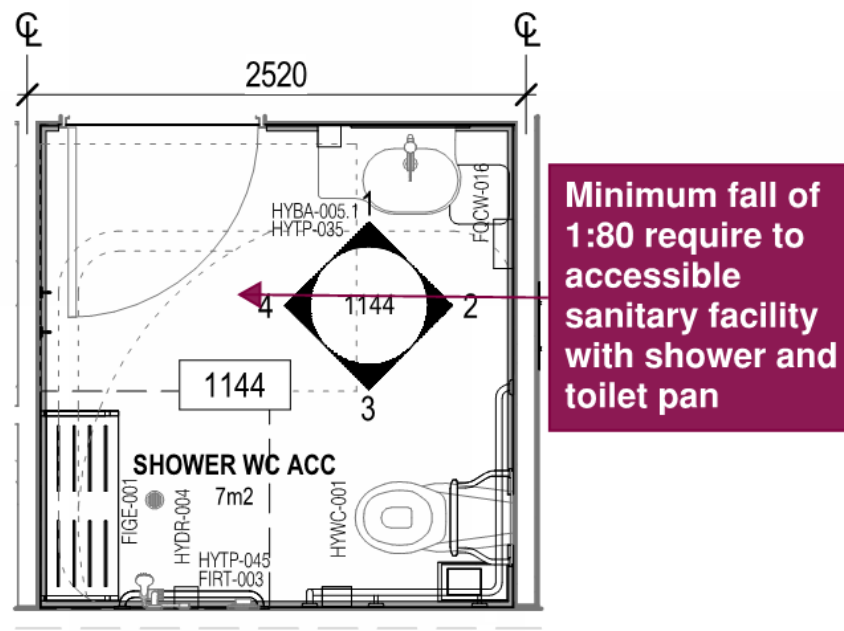

Figure No. 50: Minimum fall of 1:80 required within the accessible bathroom containing the toilet pan and shower

Part F3 Roof and Wall Cladding

F3D2

Roof Coverings:

A roof covering is required to comply with one of the following in accordance with NCC 2022 as part of a DTS Solution:

- + Roof tiles complying with AS 2049 and fixed in accordance with AS 2050; or
- + Metal sheet roofing complying with AS 1562.1; or
- + Plastic sheet roofing designed and installed in accordance with AS 1562.3; or
- + Terracotta, fibre-cement and timber slates and shingles designed and installed in accordance with AS 4597.
- + An external waterproofing membrane consisting of materials complying with AS 4654.1 and designed and installed in accordance with AS 4654.2

If the proposed roof covering is not designed in accordance with one of the above, then a Performance Solution will be required to be prepared to demonstrate compliance with Performance Requirement F3P1 with regards to adequate weatherproofing.

F3D5

Wall Cladding:

Wall cladding is required to comply with one of the following in accordance with NCC 2022 as part of a DTS Solution:

- + Masonry, including masonry veneer, unreinforced and reinforced masonry in accordance with AS 3700
- + Autoclaved aerated concrete in accordance with AS 5146.3
- + Metal cladding in accordance with AS 1562.1

If the proposed wall cladding is not designed in accordance with one of the above, then a Performance Solution will be required to be prepared to demonstrate compliance with Performance Requirement F3P1 with regards to adequate weatherproofing.

Part F4 Sanitary and Other Facilities

F4D4

Sanitary Facilities:

Staff Sanitary Facilities

Sanitary facilities must be provided to comply with the requirements of F4D4.

In relation to the proposed sanitary facilities indicated on the Design Development Architectural Drawings, the following items are noted:

- + Verification is required as to the total number of staff that will be employed to work in the building at a single time to ensure that an adequate number of sanitary facilities are provided having regard to staffing numbers.

Based on the current provision of only (2) dedicated staff sanitary facilities (one of which is a unisex accessible sanitary facility) the total male and female staff that can be employed is as follows:

- ▲ Female Staff – 30
- ▲ Male Staff -10

It is noted that the Design Development Design has deleted a Staff Sanitary Facility from the previously issued Schematic Design. The reduction has resulted in the maximum male staff population within the building at any one time being reduced from twenty-five (25) to ten (10).

If the unisex accessible sanitary facility located within the Waiting Room area can be used by staff and members of the public, then the total number of male staff can be increased to twenty-five (25).

Written verification is to be provided from the LHD that the unisex accessible sanitary facility within the Waiting Room area can be used by LHD staff.



Figure No. 51: Proposed staff sanitary facilities

Public Sanitary Facilities

Sanitary facilities for the public are technically not required to be provided within a building of Class 5 classification.

Notwithstanding the requirements of the BCA, it is noted that a unisex accessible sanitary facility for use by a person with a disability has been provided within the Waiting Room in addition to a sanitary facility for a member of the public within the consultation area as detailed in the figure below:

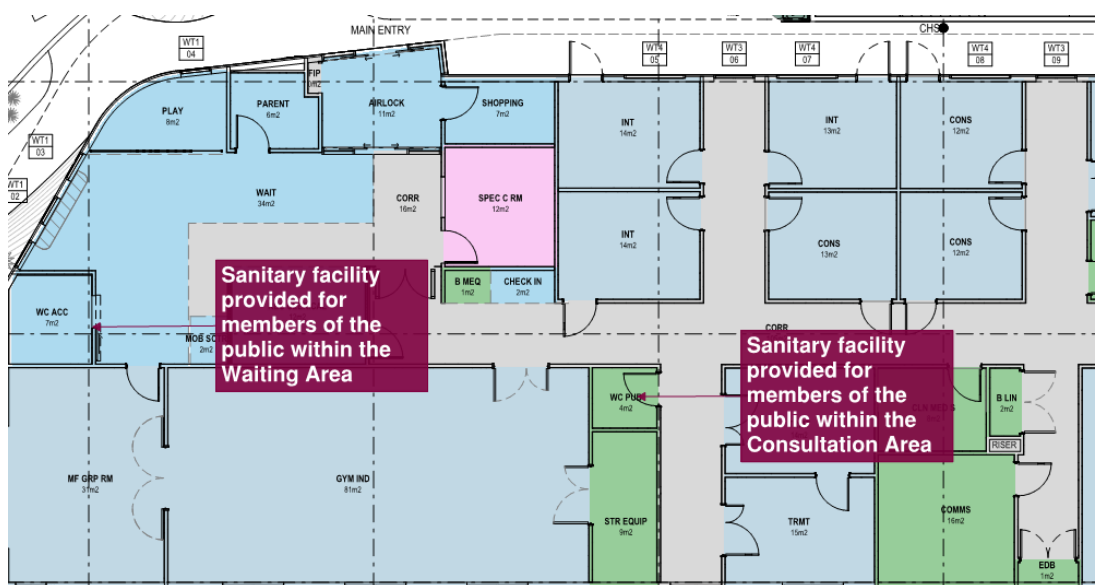

Figure No. 52: Public sanitary facilities

Part F5 Room Heights

F5D2

Height of Rooms and Other Spaces:

The minimum ceiling heights required throughout the development are as follows –

- + Meeting Rooms, Staff Rooms, Consultation Rooms, Waiting Room, Interview Rooms, Gym etc – 2.4 m
- + Storerooms, Dirty Utilities, Bathrooms, Shower Rooms, Plant Areas etc – 2.1 m
- + Corridor, passageway or the like – 2.1m.
- + Plant within the undercroft area – 2.1 m.

The Design Development Reflected Ceiling Plans indicate that the minimum ceiling heights have been documented throughout the building.

Part F6 Light and Ventilation

F6D2

Provision of Natural Light:

Based on the building classification and use, natural light is not required to be provided in accordance with the DTS Provisions of the BCA.

F6D5

Artificial Lighting:

Artificial lighting is required to be provided in accordance with AS 1680.0 - 2009.

Artificial lighting is required to be provided to all stairways, passageways and ramps.

If natural light of a standard equivalent to that required by Clause F6D3 is not available, and the periods of occupant or use of the room or space will create undue hazard to occupants seeking egress in an emergency then artificial lighting is required to be provided to all rooms that are frequently occupied, all spaces required to be accessible, all corridors, lobbies, internal stairways, other circulation spaces and paths of egress.

F6D6

Ventilation of Rooms:

The building is required to be ventilated by either natural or mechanical ventilation in accordance with the DTS Provisions of the BCA and AS 1668.2.

Natural Ventilation to rooms will be required to be verified by the Architect, whereas the provision of Mechanical Ventilation and Air Conditioning will be required to be verified by the Mechanical Design Consultant.

3.7 Section G – Ancillary Provisions

Part G5 Construction in Bushfire Prone Areas

G5D2

Application of Part:

The Deemed-to-Satisfy Provision of Part G5 apply in a designated bushfire prone area.

A designated bushfire prone area is defined as:

Land that:

- (a) *Has been designated under legislation; or*

*(b) Has been identified under an environmental planning instrument, development control plan or in the course of processing and determining a development application.
As land that can support a bushfire or is likely to be subject to bushfire attack*

It is understood that the property does not meet the definition as detailed above as thus Clause G5D2 is not applicable to the development. Formal written advice confirming the above is required to be submitted by the Applicant.

3.8 Section J – Energy Efficiency

Part J

Energy Efficiency:

The new building works are subject to compliance with the Energy Efficiency Provisions of BCA 2022 Section J relating to (as applicable):

- + J1: Energy Efficiency Performance Requirements
- + J2: Energy Efficiency
- + J4: Building Fabric
- + J5: Building Sealing
- + J6: Air-Conditioning and Ventilation
- + J7: Artificial Lighting and Power
- + J8: Heated Water Supply and Swimming Pool and Spa Pool Plant
- + J9: Energy Monitoring and On-Site Distributed Energy Resources

4.0 Conclusion

This report contains an assessment of the referenced REF Issued Architectural Design Development Documentation for the proposed delivery of the Batemans Bay Healthone facility at 7 Pacific Street, Batemans Bay NSW against the deemed-to-satisfy provisions of the Building Code of Australia 2022.

Further reviews will be undertaken by **BM+G** as the design progresses to ensure that the development can comply with the requirements of the Building Code of Australia, however **BM+G** are of the opinion that the proposed design reviewed is capable of complying with the requirements of the Building Code of Australia without giving rise to any significant changes that would require any proposed modifications to the Review of Environmental Factors to be approved by Health Infrastructure.



Appendices

+ Appendix 1 – References Tables

Table 1: Non-Combustibility Requirements

+ Building Element	+ Type C Construction
External wall	Non-combustible
Common wall	Non-combustible
Floor and floor framing of lift pit	Non-combustible
All loadbearing internal walls (including those of shafts)	Concrete, masonry or fire-protected timber
Loadbearing fire walls	Concrete, masonry or fire-protected timber
Non-loadbearing internal walls required to be fire-resistant	Non-combustible
Non-loadbearing lift, ventilating, pipe, garbage and the like shafts which do not discharge hot products of combustion.	Non-combustible (subject to conditions outlined in C2D10)

Table 6: Fire-Resisting Construction – Type C Construction

TYPE C CONSTRUCTION: FRL OF BUILDING ELEMENTS				
+ Building Element	+ Class of Building - FRL: (in minutes) Structural adequacy/integrity/insulation			
	2, 3 or 4 part	5, 7a or 9	6	7b or 8
EXTERNAL WALL – (Including any column and other building element incorporated within it) or other external building element, where the distance from any fire-source feature to which it is exposed is:				
For loadbearing parts:				
Less than 1.5m	90/90/90	90/90/90	90/90/90	90/90/90
1.5 to less than 3m	-/-/-	60/60/60	60/60/60	60/60/60
3m or more	-/-/-	-/-/-	-/-/-	-/-/-
EXTERNAL COLUMN - Not incorporated in an external wall				
Less than 1.5m	90/-/-	90/-/-	90/-/-	90/-/-
1.5 to less than 3m	-/-/-	60/-/-	60/-/-	60/-/-
3m or more	-/-/-	-/-/-	-/-/-	-/-/-
COMMON WALLS and FIRE WALLS	90/90/90	90/90/90	90/90/90	90/90/90
INTERNAL WALLS				
Bounding public corridors, public lobbies and the like:	60/60/60	-/-/-	-/-/-	-/-/-
Between or bounding sole-occupancy units:	60/60/60	-/-/-	-/-/-	-/-/-

Bounding a stair if required to be rated:	60/60/60	60/60/60	60/60/60	60/60/60
ROOFS	-/-/-	-/-/-	-/-/-	-/-/-

Notes:

1. External walls that are located 3.0 m or more from an allotment boundary / fire source feature require no FRL's.
2. Where a part of a building required to have an FRL depends upon direct vertical or lateral support from another part to maintain its FRL, that supporting part must typically achieve the same FRL. Where that part is also required to be non-combustible, the supporting part must also be non-combustible.
3. An external wall required to have an FRL is only required from the outside.
4. Any lightweight construction in a fire wall or an internal wall required to have an FRL is to comply with Specification 6.
5. The method of attaching or installing a finish, lining, ancillary element, or service installation to a building must not reduce the fire-resistance of that element to below that required.
6. No structural elements are permitted to pass through fire-rated walls.